

Article number: 2310431053S

Description: E+G Levelling elements
LX.30-SW17-M6X34-S

Measures

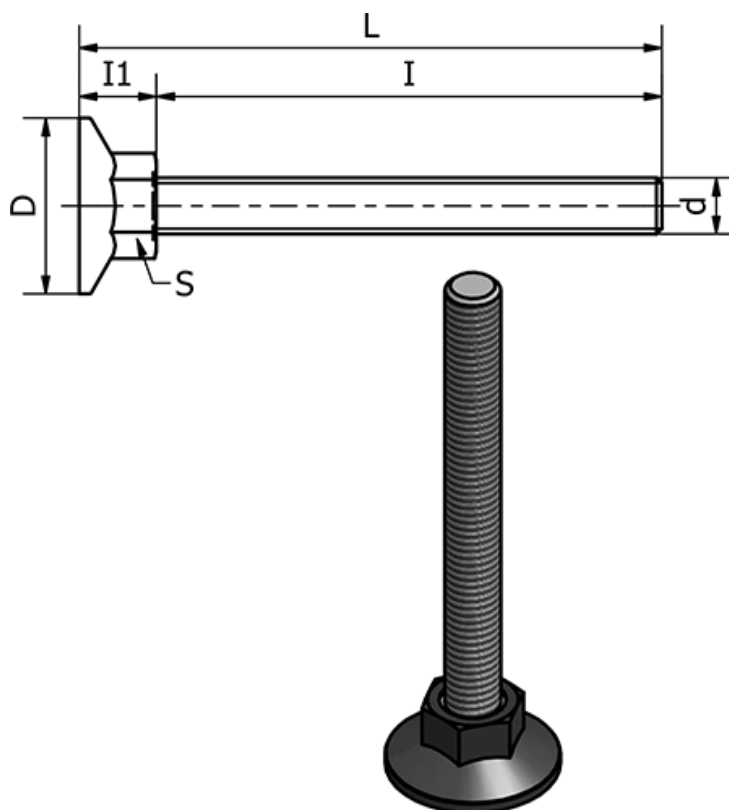

d	= M6
D	= 30
I	= 34
I1	= 12
L	= 46
S	= 17
Static load in (N)	= 1500
Type	= Forzinket

Weight (g) = -